

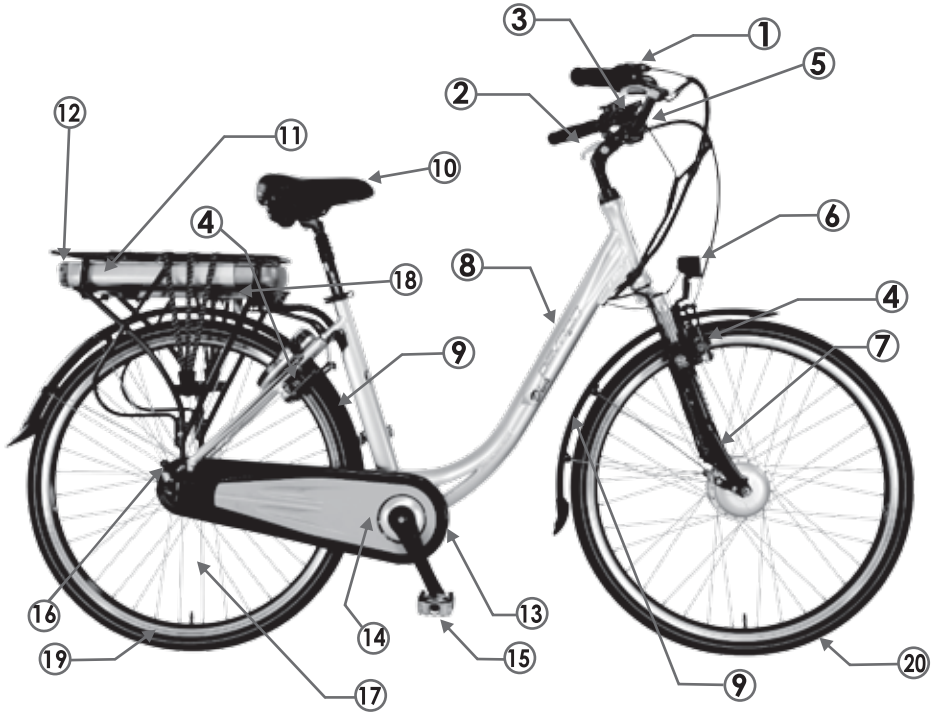

**DEVRON**



**OWNER'S MANUAL  
and warranty certificate**



**INDEX:**

- 1 - manetă schimbător viteze / shifter
- 2 - manetă frână / brake lever
- 3 - panou de control / panel
- 4 - frână / brake
- 5 - ghidon / handle bar
- 6 - far / front lighter
- 7 - furcă / fork
- 8 - cadru / frame
- 9 - aripă protecție / fender
- 10 - șa / saddle
- 11 - acumulator / battery
- 12 - stop / rear lighter
- 13 - senzor sistem asistare la pedalare / assist pedal sensor
- 14 - apărătoare angrenaj pedale / guard gear pedal
- 15 - pedale / pedals
- 16 - schimbător spate / rear derraileur
- 17 - motor / gear
- 18 - portbagaj / carrier
- 19 - jantă / rim
- 20 - anvelopă / tire

## Congratulations

You are the owner of a DEVRON electric bike. This bike is equipped an electric pedal assistance which offer a whole new way practicing cycling. The pedal assist makes driving more lightweight and comfortable than ever. Whether you use your bike for trip between home and work, for heavy shopping or just for pleasure, you will always have the wind at your back. With the electric assist reliable, durable and easy to use, your effort becomes a pleasure. Please carefully read this manual and keep it in a safe place for future reference in case of need.

Have a fun addition to your cycling !

## Summary :

1. Panel
  - 1.1. Information on the screen
  - 1.2. Adjusting the pedal assist
2. Battery
  - 2.1. Precautions
  - 2.2. Disconnect and remove the battery
  - 2.3. Charge the battery
  - 2.4. Battery informations
3. Pedalhelp
  - 3.1. What assistance pedaling ?
  - 3.2. You still need to know about pedaling assistance
4. Saddle
  - 4.1. Seat height desired
  - 4.2. Adjusting the saddle
5. Pedals mounting
6. Lighting
  - 6.1. Turning the light On and Off
7. Brakes
  - 7.1. Information about the brake adjustment
  - 7.2. Brake adjustment
  - 7.3. Replace brake pads
8. Anvelope
  - 8.1. Tire presure
9. Viteze
  - 9.1. Shifting
10. Întretinere
  - 10.1. Revisions
  - 10.2. General maintenance
  - 10.3. Cleaning
  - 10.4. Lubrication
  - 10.5. Periodic Revisions
  - 10.6. Regular control
  - 10.7. Bike Transport
11. Warnings
12. Warranty Conditions
13. Warranty Certificate

## 1. Panel

### 1. Panel

#### 1.1. Information on the screen

Make sure that the battery has to be lit. Activate the control panel using the (Fig.3)

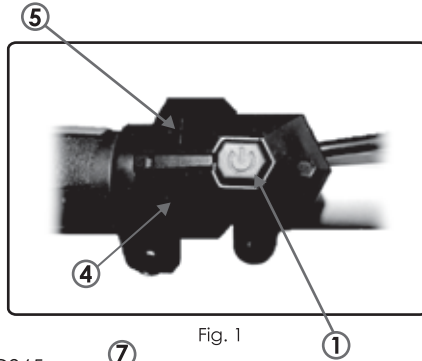

Fig. 1

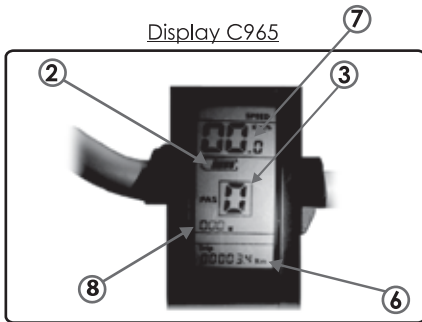

Fig. 2

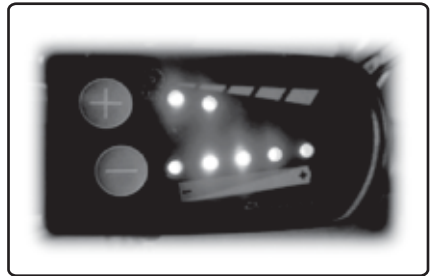

Fig. 3

1	START / STOP
2	Battery indicator
3	Assistance level
4	Adjustment assistance/walk assist**

5	Adjustment assistance/Display & backlight lighting*
6	Mileage*
7	Travel speed*
8	Motor Power*

\* Optional depending on the model control panel

\*\* Functions activate/deactivate holding the button press for 2 seconds

#### Caracteristicile display-ului C965

#### Material & color

The C965 display is made of ABS and is designed to perform well under -20° to 60 ° C.  
Available colors: black

### Functions & buttons

The C965 offers many functions for your riding pleasure. These Include : Multiple Power levels settings (Mode), Remaining Battery Capacity, Speed ( Speed/ MAX/AVG ), Distance and Odometer (TRIP/ TOTAL), Time, Assist walking (slow speed motor assist), Backlight, Error codes.

#### Interface

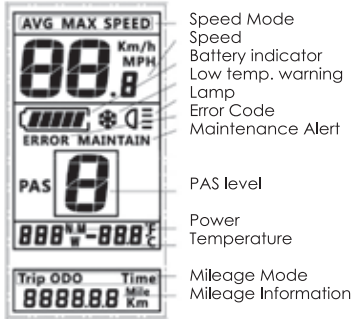

#### Buttons

C965 includes a three button control electronic switch.

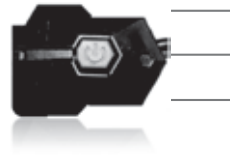

- " + "
- Power On/ Off
- " - "

Caution : Do not plug in or unplug this display when the power to the unit is on !



Avoid collisions



Protect the display's membrane to provide water resistant performance



Do not attempt to reset parameters if the display is not working



Call for service if the C965 display is not working

#### Installation

Install the display and button control on the handlebar and adjust its location. Plug it into the controller with power off.

#### ON/OFF

To turn the unit on, press and hold the button to start the display. A long press again will switch it off.

**The display switches off automatically if there is no activity for ten minutes (default).**

#### Walking assist

Press and hold to start the walking assist. You will see the walking icon on the display and the motor will move the bicycle or vehicle at 6km/h.



**This function is designed for walking alongside only. Please do not use this function when riding.**

#### Backlight

Press and hold to turn on the C965's backlight screen. If a front/back light is configured as well, this will switch it on as well if front light available. Press and hold again to switch off.

**Note : The automatic backlight is available only if the controller (or built-in controller) offers this function.**

## 1. Panel

### Power Level

The display is integrated with the controller to provide several levels of power. Press  or  to change the levels. The Default range is 0 - 5, where 0 means no output, and 5 means maximum output. The default switch-on is level 1.

### Battery Capacity

Four sections highlights when battery is full.  
Percentage of capacity for sections :



The battery icon flashes at 1 Hz when low power.

### Distance (trip and odometer)

Press  to shift between TRIP and TOTAL (Odometer).

### TRIP Reset

With the power on, Press and hold both  and  to clear TRIP distance.

### Error codes

When something goes wrong with system, an error code will flash on the display, in this case we strongly recomand to contact your service unit/technician.



**The motor will stop working in the event of an error. Only when the error is gone, will the motor work again.**

## 2. Battery

### 2.1. Precautions

Precautions charger :



Only for indoor use.



Do not throw the charger in innappropriate containers.



Danger of electrocution. Do not disassemble the charger.



Double isulation.

Precautions battery :



Do not incinerate the battery.



Do not expose the battery to temperatures above 50°C.



Do not expose the battery to water. Do not immerse the battery in water.



Do not dispose of batteries and batteries in inappropriate containers.



Prevent the battery from draining completely (deep discharge) because it shortens the battery life. ( no warranty claims ).

## 2. Battery

### 2.2. Remove the battery from the bike

Insert the key into the lock and turn the key 180 ° to the left to unlock the battery. Carefully pull the battery from the holder.

Fig 1 and Fig. 2 - explanations whose electric bike battery is mounted on the carrier.



**Fig. 1**



**Fig. 2**

Insert the key into the lock and turn the key 180 ° to the left to unlock the battery .  
Fold bicycle saddle by pressing vertical locking rod under saddle. Carefully pull the battery from the holder using its folding handle.

### 2.3. Charger in battery

The electric bicycle is equipped with a Lithium-Ion battery that powers the motor. Unlike other batteries, Lithium-ion batteries are not subject to a "memory effect" and can be recharged even if they are not completely empty.

The total battery capacity is reached after several loads and unloading.

The first time, the battery must be charged for 12 hours.

We recommend that always, the batteries, to be charged at maximum capacity (100%).

- First connect the charger to the battery. The connection to the battery is located on the right side of the battery, sometimes be masked by a protective rubber flap.

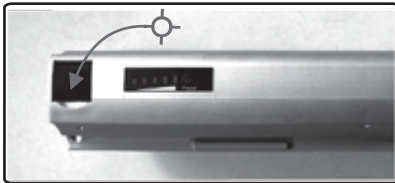

- Only then insert the charger plug into a power outlet.

During charging, the charger LED lights red to indicate that the battery is charging. The LED turns green when the battery is fully charged.

- After charging, remove the plug from the wall outlet first and then only plug battery charger.



If the LED does not turn red, it may be that the battery is too hot. Let it cool then before loading.



On the side of the battery is an indicator of the state of battery charge. By pressing the red button (POWER) you can check the battery charge. LEDs indicate battery charge status as follows:  
 5 LED = the battery is 100% charged  
 3 = LED load is between 70 and 40%  
 1 LED = battery is charged between 0% and 40%

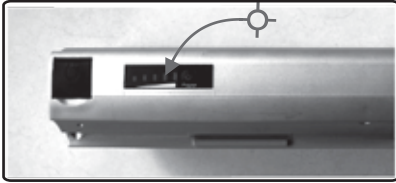

If no LED is lit, the battery is empty and must be recharged.

## 2.4. Battery Information

- Never put the battery shorted by contacting terminal positive and negative.
- The battery is sealed and water and rain resistant. So you can very well use your bike in wet weather. However, try not to expose the battery to excessive quantities of water.
- The environmental consequences are not important, electricity is a form of clean energy. End of life, however, should your battery (like all batteries) be submitted for recycling
- Benefits your battery will decrease with lower temperatures\*
- Under ideal conditions, the battery pack can be fully recharged about 1000 times. Over time and use, the benefits of the battery will gradually decrease and it will eventually replace all
- Do not expose the battery to high temperatures (> 50 ° C), such as heat, direct sunlight and heat
- Do not disassemble the battery. Consult the dealer in case of problems.
- For long storage, place the battery in a dark and dry place with temperatures between 10 and 20 ° C
- If you don't use the batteries for a longer time, it's important to completely recharge them to 100% once in 6 months.

Use only the charger provided.

\* Toate specificațiile menționate sunt valabile pentru utilizarea la o temperatură de 25°C. Ca regulă generală, randamentul acumulatorului scade cu 1% pentru o scădere a temperaturii cu 1°C.

### 3. Pedalling assistance

#### 3.1. What is pedalling assistance ?

This bike is equipped with an electric pedal assist. Engine complete your own efforts. The operation of the pedalling assistance depends pedaling pedal rotation. Assistance works when pedaling motion sensor identifies and stops when the movement stops, or when the brakes are operated.

If you do not pedal, the engine is idle. When it starts, the assistance provided by the motor increases and allows smooth and easy starts.

#### 3.2. You still need to know about pedalling assistance

When the electric power steering is enabled, start the bike is different than a normal bike. You will leave more easily. Do not let yourself surprised by the operation of the bike and before use in high traffic areas acclimate yourself with it. We recommend that you use the assistance program 1 to start when you are stationary.

When the electric power steering is disabled, the bike offers very little extra resistance. You can always use the bike as a regular bike, even without a battery.

The pedalling assistance is legally limited to a speed of 25 km/h, which means that from 23 km/h, the decrease pedaling assistance gradually disappear completely at 25 km/h.

The range of cycling depends on the circumstances. The values shown have been measured in average conditions. The main factors are: the weight of the rider, driving speed, ribs in the course, the tire pressure, the headwind, the number of gear changes and braking (in town) and the outside temperature. When temperatures are very low, the radius of action undergoes a very negative influence. Keep this in mind!

Some models of electric bicycles have the motor positioned on the front wheel (Fig. 1), the other models the engine is positioned in the center of the frame, under the bottom bracket (Fig. 2) or on the back wheel (Fig. 3).



Fig. 1



Fig. 2



Fig. 3

## 4. Saddle

### 4.1. Seat height desired

By seat height means the distance between the seat portion of the seat and pedal down position. The seat height is properly adjusted when the knee is bent slightly so that your foot rests on the pedal (low position) (Fig. 1). Do not hesitate to ask your advisor cycle!

### 4.2 Adjusting the saddle

You can adjust the seat height by loosening screws ( or by operating the "Quick Release", where the model of bicycle is equipped with this system) on the stem clamp to the saddle, using an hexagonal key (Fig. 2).



Fig. 1

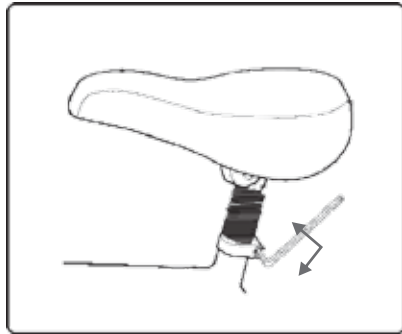

Fig. 2

You also have the option to switch the saddle and adjust as forward to the rear (Fig. 3). To do this, loosen using the spanner nut on the carriage seat (Fig.4). Once you've got the right position, do not forget to tighten the nut.

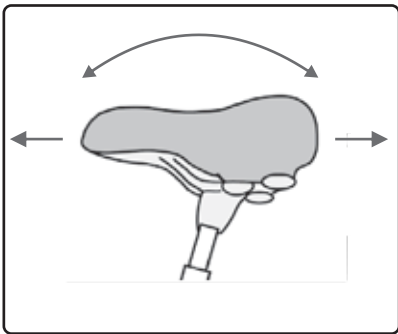

Fig. 3

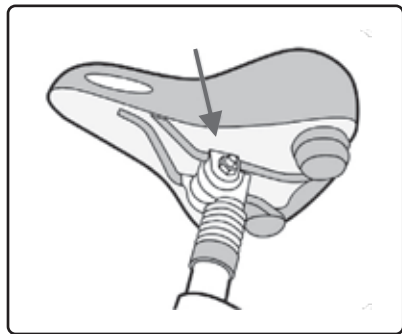

Fig. 4

## 5. Pedals mounting

On each pedal you can find two letters: R and L, (Figure 1) they represent positions where the pedals must be mounted; R for right side and L for the left side.

After they are identified, it is recommended to screw easy with your hand. Make sure that they enter easy in their channel and you will not force them, because of the risk of damaging the threads. The last step is squeezing pedals with a key (No. 15), in the direction of pedaling, identical to both pedals. (Fig.2)

Fig.1

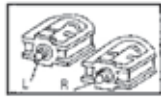

Fig.2



## 6. Lighting

### 6.1. Turning the light On and Off

The bike is equipped with lighting system ( headlight & rear stop ) powered by batteries or dynamo. To turn on the bike headlight, please glide the side button that you can find on the left side of headlight. (Fig.1)

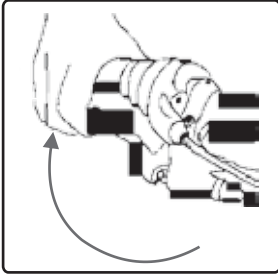

Fig.1

## 7. Brakes

### 7.1. Information about the brake adjustment

The brakes must be adjusted so that when you squeeze the handle to the half of the stroke (FIG. 1), the whole braking surface of the brake pads bear against the rim (Fig.2)



**Fig. 1**

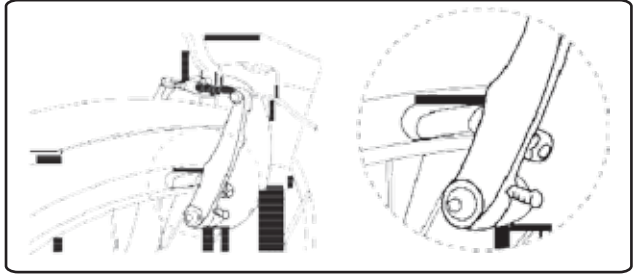
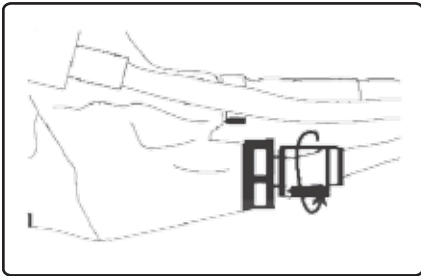

**Fig. 2**

### 7.2. Brake adjustment

If you feel that your brakes are not to your taste, you can adjust your brakes with screw cable tension. That is if in your brake lever (Fig. 3).

Tightening the screw cable inward relax a little cable so you spread the pads and the loosening outward, you stretch the cable so the pads closer to the rim.



**Fig. 3**

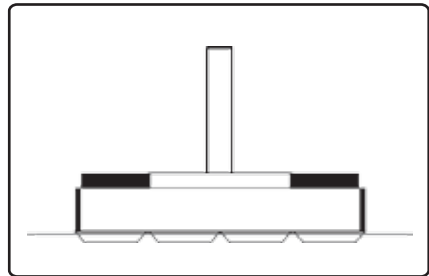

**Fig. 4**

## 8-9. Tires / Speeds

## 7.3. Replace brake pads

The brake pads should be replaced when the grooves are no longer visible ( Fig. 4 ).

To replace the brake pads, you must first turn the screw inward cable so that the cable brake relax. Then, push the brake levers using the thumb and forefinger and pull the brake cable (Fig. 5). You have enough space to loosen the bolts brake pads (Fig. 6).

Do not forget to have correct brake adjustment after replacing the pads.

Do not hesitate to ask your dealer to do this for a perfect result and enhanced security.

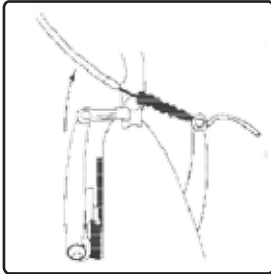

Fig. 5

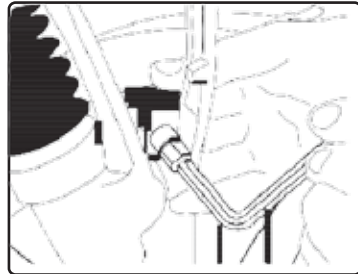

Fig. 6

## 8. Tires

## 8.1. Tire pressure

Tire pressure affects autonomy and comfort of your bike. It is advisable to always inflate your tires. It is advisable to regularly check your tire pressure.

Maximum pressure is recommended by the manufacturer and marked on the tire.

## 9. Speeds

## 9.1. Shift

The bike can be equipped with 3x1 transmission hub, Shimano Tourney transmission 7x1 or 8x1 transmission Shimano Tourney. Gear shift lever is rotary type, having the possibility of changing your running speed by rotating them forwards or backwards, respectively to move up a gear or a lower. Depending on the model of your bike fitted shifting, changing to a higher gear can be forward or backward, according to the location indicated on the lever ("+" and "-").

It is important that the gear changes to be made while pedaling, not to cause damage to the transmission. If the hub exchangers efficiency is better if shifting is done when not pedaling. If there is a malfunction of the system of transmission, contact your authorized service specialist garage to make a corresponding adjustment.

## 10. Maintenance

### 10.1. Revisions

We recommend that you make regular checks of the bike to your dealer or an authorized service facility. It is recommended to do a review after 3 months of use, and regularly up to 1 year. A regular maintenance can prevent long-term damage and unnecessary costs. Obviously, it helps to keep your bike in optimum operating condition for a longer period of time. Next you will find some useful tips for proper use of your bicycle.

### 10.2. General maintenance

1. Check the pressure and tire profile
2. Check brake wear, make from time to time fine tuning
3. Clean the pedal sensor with a sponge and warm water in case very dirty
4. Lubricate the chain
5. If you notice a problem with rays on one of your wheels, make immediate repairs to your dealer

### 10.3. Cleaning

You can clean your bike by removing dirt with a brush and then washing with hot water. Your bike will be clean again. A regular cleaning of the cycling life improves. Do not use too much water around the battery. Also make sure that dirt does not fit between the washer and the magnetic sensor (near the bottom bracket on the right side of the bike).

Never use a pressure washer !  
After cleaning your bike dry with a soft cloth.

### 10.4. Lubrification

In addition to regular cleaning, it is advisable to proceed at the same time to lubricate the transmission in order to avoid corrosion and comfort in the gears. We recommend lubricating your chain with vaseline oil available from your dealer.

### 10.5. Recommended periodic revisions (in accordance with the legislation of each country)

1st Revision after 3 months :

- Check the wheels and tires. (Sailing wheels, spoke tension, pressure tires, tire condition.)
- Checking all the bike tightening.
- Brakes: Check the brake pads wear - Adjust the cable tension - Check the braking efficiency.
- Check the play in the steering - Check the attachment of the hanger
- Lubrication : Clean and lubricate the chain with a suitable lubricant
- Electrical System: a fully charged battery (the client is obliged to review and bring the charger) - the dirt from the sensor net pedal with a sponge and warm water - Check the electrical part works correctly.
- Derailleur - Check all speeds going well smoothly, adjust if necessary.

Then a complete overhaul every year.

## 10.6. Regular control

Be sure to check the following :

- Is the battery charged ?
- The brakes work properly ? Brake pads, bolts and nuts are tight ? Cables they are not damaged ? The braking surfaces are kept clean and grease? There is the noi-fi brake pads worn?
- My bike is set correctly ? The saddle and handlebar they are not beyond the maximum allowable position ? My handlebar is it aligned with the front wheel ?
- The tension in the spokes is it still enough ? There he was not sailing in the wheel ? Are there no broken spokes ? There he has no play in my wheels ?
- My tires are properly inflated ? They are not worn ?
- The stem is it tight ? My saddle is it tight ?
- My lights work? I'm visible at night ? The reflector surfaces are thoroughly clean them ? Reflective strips on my tires are they in place and if so, are they clean ?
- The pedaling assistance does it work properly ?
- Speeds do they work as they should ?
- My bike does not he need a cleaning ?
- I recently submitted my bike a review ?

## 10.7. Transportul bicicletei



To transport your bike always use systems (supports) approved and in good condition. Bicycle transport using improvised or damaged systems can cause malfunction of bicycle components that can produce injuries or major material damage.

If you choose to carry the bike inside the car you have to place the bike and the other component so that it can not be affected by other luggage during transport.

During the transport while the bike is inside the car it is possible that solar radiation to cause tire blowout or their exit from the rim. Please reduce the air pressure in the tires and restore it to the destination.

## 11. Warnings

- Read the instructions of this manual carefully and follow them properly.
- If you want to charge the battery, use only the supplied battery charger.
- Use the battery for your bike.
- Do not wash the bike with a high pressure jet. Too powerful jet of water can damage the electronics of the bike. The warranty will be invalidated.
- In case of inappropriate use, you can put yourself in person or others at risk. In addition, the warranty is void in the event of misuse.
- Do not insert objects into the charger and do not expose either the charger or the battery electronics to water or other liquids.

### SERIAL NUMBERS

**You will find the serial number on the bike, in the joint of the front fork of the bicycle frame.  
This number is unique, identifying your bike**



## 12. Limited warranty

DEVIRON guarantees for defects regarding the materials and workmanship:

- motor, battery and controller for a period of two (2) years after the purchase date
- framework for a period of five (5) years after the purchase date
- remaining components for a period of two (2) after the purchase date

### **This warranty does not cover :**

- Normal wear and tear
- Improper commissioning
- Improper follow-up maintenance
- Installation of parts or accessories not originally intended for, or compatible with, the bicycle as sold
- Damage or failure due to accident, misuse, abuse, or neglect
- Labor charges for part replacement or changeover
- Underperformance of the battery-pack if it has been fully discharged and charged more than 600 times within warranty period.
- Any damage to the battery pack after the battery has been opened by the dealer or consumer.
- Any damage caused by installing a child seat.

This warranty is void in its entirety by any modification of the frame, fork, or components. This warranty is expressly limited to the repair or replacement of a defective item and is the sole remedy of the warranty. This warranty extends from the date of purchase, applies only to the original owner, and is not transferable.

DEVIRON is not responsible for incidental or consequential damages. Some states do not allow the exclusion of incidental or consequential damages, so the above exclusion may not apply to you. Claims under this warranty must be made through an authorized Trek dealer. Proof of purchase is required.

The subject item must be registered with DEVIRON, either through on-line registration or by the receipt of a warranty registration card by DEVIRON, before a warranty claim may be processed.

Warranty duration and detail may differ by frame type and/or by country. This warranty gives the consumer specific legal rights, and those rights may vary from place to place. This warranty does not affect the statutory rights of the consumer.

13. Warranty Certificate

ENGLISH

IDENTIFIERS

BARCODE  
Frame Series

BARCODE  
Engine Series

BARCODE  
Battery Series

BARCODE  
Controller Series

# WARRANTY CERTIFICATE

- ELECTRICAL BICYCLE -

For,

Electric bicycles, name \_\_\_\_\_ recommended age group minimum 16 years.

Model \_\_\_\_\_, color \_\_\_\_\_, sold by shop \_\_\_\_\_, town \_\_\_\_\_, address \_\_\_\_\_

Product purchase invoice \_\_\_\_\_, date \_\_\_\_\_ voucher / receipt \_\_\_\_\_, date \_\_\_\_\_

Shop stamp

Commisioning was performed, I was handed manual and showed me how to use, I agree the terms of warranty.

Signature seller

Signature \_\_\_\_\_  
Name \_\_\_\_\_  
ID Card series \_\_\_\_\_ Number \_\_\_\_\_  
Phone number \_\_\_\_\_

**Warranty repairs will be performed only in specialist garage.**

SC Eurosport DHS SA offers a warranty of 24 months from the date of purchase bicycle in accordance with the rules provided by Law 449/2003 amended Ordinance 21/1992 republished on durable goods. The average use of the bicycle is 5 years. Ensuring security is a bicycle repair or replace it - if applicable - no later than 15 calendar days from the date the complaint was lodged by the purchaser to the selling unit, according to the law 449/2003 as amended. The warranty period shall be extended by bicycle elapsed from the filing date of the complaint till the date of recovery bike in running. Claims made by the purchaser during the warranty period will be considered only if the invoice / voucher and a certificate of guarantee with all sections completed.

**1. CONSUMER RIGHTS** - are those provided by law 449/2003 as amended, Chapter III.

- The seller is liable to the consumer for any lack of conformity existing at the time the products have been delivered in accordance with article 9 ;
- In case of lack of conformity, the consumer has the right to ask the seller, as a remedy, repair the product its option, in each case free of charge, unless this requirement is impossible or disproportionate, article 1.
- The consumer is not entitled to seek rezolutionarea contract if the lack of conformity is minor.

**2. CONDITIONS OF LOSS OF WARRANTY**

- Damage and malfunction caused by improper transportation performed by the buyer.
- Losing having filled in warranty certificate.
- If the bicycle or its color series do not correspond with the series or color listed in the warranty.
- Damage caused by buyer misuse of the product, contrary to the recommendations in the manual (strikes, accidents, overloading, acrobatics, jumping, contests, etc..)
- The bike has not been used as the operating and maintenance instructions.
- Interventions warranty unauthorized by Eurosport DHS SA.
- Using products for purposes other than those for which they were designed.
- Improper storage, improper under the bike.
- Bike show dents, bends.
- Failure Periodic revisions.
- Failure commissioning bicycle before first use will void the warranty.

Warranty does not cover damage caused by improper use non-observance of accidents, improper maintenance or commercial use of the product.

This bike has a personal use and not a professional.

**3. UNDER WARRANTY**

**MANUFACTURERS OFFER 5 YEAR WARRANTY ON THE FRAME, 12 MONTHS TO BATTERY 12 MONTHS TO 12 MONTHS TO DISPLAY MOTOR CONTROLLER AND THE ELECTRIC AND 24 MONTHS AT THE REMAINING COMPONENTS, EXCEPT THE ONES CONSUMERS.**

- **Front and rear hubs** - change if cracks or defects hidden basins, does not change if it has dents or rim of shaft.
- **Wheels** - change if cracked without showing dents, does not change if it found the use of state-center.
- **Chaining** - if changes occur distortion, breakage or tooth crank no dents, no change if damaged in the thread.
- **Derrailleurs** - change if manufacturing defects without dents or misuse.
- **Shifters** - change manufacturing cracks does not change if the cable is damaged due to incorrect handling.
- **Freewheels** - change if it breaks or one pawl teeth, does not change if tampered with or if it's because it was not properly maintained.
- **Brake levers** - change if manufacturing defects, no dents, no changes if it finds breakage due lock brake cables.
- **Chain** - change only if manufacturing defects.
- **Handlebar and handlebar bracket** - changes cracks due to manufacturing, no dents.
- **Pedals** - change only if manufacturing defects no dents. If they show dents entails warranty on gear sheet. Not change if the joint is affected due to any subsequent installation time of purchase.
- **Crank shaft** - if only changes if manufacturing defects.
- **Brake** - change if you show signs of cracking, manufacturing defects, no dents.
- **Tires** - will be replaced if defective manufacturing. There will be replaced if they have cuts, uneven wear due to excessive braking or normal wear.

Please read carefully the recommendations of manual electric bicycle to get to know the operational measures and especially your obligations.

## 13. Warranty Certificate

It is imperative for your safety to follow the rules of protection presented in this manual.

- maximum speed : 25 km/h
  - maximum user weight : 120 kg
  - autonomy : 50 km ( based on the weight of the user and land )
  - Battery - warranty 12 months, changeable if it presents manufacturing defects.
- Features: Lithium - Ion recharge cycles - up to 600, with over 80% efficiency,removable - will be charged using a regular outlet.
- Motor : changeable if it presents manufacturing defects.
- Features : Aluminum housing, brushless hub framed front, rear or below the crank shaft, depending on model.
- Charger : changeable if it presents manufacturing defects.
  - Display : the warranty does not cover screens that present traces of fissures,breakage or anu other voluntary or involuntary impacts. Changeable if it presents manufacturing defects.
- Features : LED, LCD or OLED, depending on the model .

**IMPORTANT :** the lost warranty of one of the above items does not affect the warranty of the rest of the components. Warranty is granted for consumable parts(chain, pedals, tires) for 30 days from the date of the purchase and is valid only for proven manufacturing defects and it is given only under instructions given by the manufacturer.

Consumer is obliged to check the operation of the product at the time of purchase and meet the product manual.

- For cables and their shirts, brake shoes, cameras, cocks, accessoriil (lights, reflectors, ribs, wings), saddle joints, the buyer may demand replacement only at the given time the purchase.
- Center wheels do not fall under warranty because of potential problems of misallignment or improper use (jumping, crossing over obstacles, turns, skidding side).
- If wheel axles front / rear are bent due to improper use ( jumping, crossing over obstacles ) hubs lose warranty.

#### COMMISSIONING OF ELECTRIC BICYCLES

Registration operation must be completed before first use throught checking the following actions :

- battery charge level : min. 25%
- efficient operation of brakes
- tyre air pressure
- proper tightening of handlebar and saddle weight
- tightening the mounting nuts correction wheel
- tightness of the nut / screw fixation, in particular suspensions and handlebar
- equipment with headlight, stop, wheel reflectors for nighttime traffic
- verify the operation of the electrical system (engine, display controller, brake sensors)
- equipment with buzzer

Commissioning is free at the time of purchase.

Under the legislation Romania has aligned to according to the category of bicycles, must include the following items :

- city, trekking - lighting, acoustic and optical, can be used on public roads
- mountain bike and kids bike - do not need lighting and can be used off-road or specially designated cycle lanes.

To travel on public roads, bicycle user is required to know and comply with legislation regarding the movement.

#### VERY IMPORTANT !

Under Romanian law on public road traffic cyclist is recommended to wear protective equipment (helmet, elbow pads, knee pads). Children will be instructed by parents / guardians on the proper use of bicycles on public roads. According to GD 1037/2010 on Waste Electrical and Electronic Equipment (DDEEE) This item is separately collected in dedicated facilities.

#### DECLARATION OF CONFORMITY

We, SC Eurosport DHS SA based in Deva, Str. Sântuhalm no. 35A, 330 004, Hunedoara, Romania, declare on oath, according to the Decision 1022/2002 regarding the products and services that may endanger the life, health, safety and the environment, the product in this manual referred to this statement not endanger the life, health, safety and the environment and is in compliance with Law 449/2003, quality technical OG 21/1992 republished.

### BEAD COMMISSIONING

Series A .....  
Service unit .....

Commissioning date .....

Signature and stamp .....

### BEAD COMMISSIONING

Authorized service .....

Series A .....

Product code..... Frame series ..... Date of purchase .....

Client name..... Phone number .....

Commissioning date ..... Entry date .....

Client signature ..... Service signature and stamp .....

### BEAD COMMISSIONING Series B .....

Service unit ..... Date entry .....

Claimed defect .....

Repair mode .....

Date of leaving the repair .....

Signature and stamp .....

I received the product repaired in proper working condition.

Client signature ..... Date .....

### BEAD COMMISSIONING

Series B .....

Seller .....

Product code ..... Frame series .....

Client name ..... Phone number .....

Purchase date ..... Receipt of the repair .....

Failure .....

Repair mode .....

Date of leaving the repair ..... Client signature .....

Signature and stamp service unit .....

### BEAD COMMISSIONING Series C .....

Service unit ..... Date entry .....

Claimed defect .....

Repair mode .....

Date of leaving the repair .....

Signature and stamp .....

I received the product repaired in proper working condition.

Client signature ..... Date .....

### BEAD COMMISSIONING

Series C .....

Seller .....

Product code ..... Frame series .....

Client name ..... Phone number .....

Purchase date ..... Receipt of the repair .....

Failure .....

Repair mode .....

Date of leaving the repair ..... Client signature .....

Signature and stamp service unit .....

### BEAD COMMISSIONING Series D .....

Service unit ..... Date entry .....

Claimed defect .....

Repair mode .....

Date of leaving the repair .....

Signature and stamp .....

I received the product repaired in proper working condition.

Client signature ..... Date .....

### BEAD COMMISSIONING

Series D .....

Seller .....

Product code ..... Frame series .....

Client name ..... Phone number .....

Purchase date ..... Receipt of the repair .....

Failure .....

Repair mode .....

Date of leaving the repair ..... Client signature .....

Signature and stamp service unit .....





EUROSPORT DHS SA

Sântuhalm Street no.35A DEVA ROMANIA  
Tel.: +4 0254 210 001 Fax: +4 0254 210 004  
www.dhsbike.ro office@dhsbike.ro